

# Clarke®



## PROFESSIONAL AUTO RANGING DIGITAL CLAMP METER - 6 FUNCTION

MODEL No: CDM95

Part No: 4500099

### OPERATING & MAINTENANCE INSTRUCTIONS



GC0620

## INTRODUCTION

Thank you for purchasing this CLARKE CDM95 Digital Clampmeter.

Please read this manual thoroughly and follow the instructions carefully, in doing so you will ensure that operations are carried out in safety and you can look forward to the product giving you long and satisfactory service.

## GUARANTEE

This CLARKE product is guaranteed against faulty manufacture for a period of 12 months from the date of purchase. Please keep your receipt as proof of purchase. This guarantee is invalid if the product is found to have been abused or tampered with in any way, or not used for its intended purpose.

Faulty goods should be returned to their place of purchase, no product can be returned to us without prior permission.

This guarantee does not effect your statutory rights.

## SPECIFICATION

UNIT SPECIFICATIONS	
Range options	Auto or Manual
Over range protection	Provided for all ranges
Max voltage between terminals & earth	600V DC or AC rms
Max operating altitude	2000 metres (7000 feet)
Display	LCD
Maximum value display	1999
Sampling Time	0.4 seconds per sample
Auto Power-Off time	15 minutes
Operating Power	3 x 1.5V AAA batteries
Operating Temp	0°C to 40°C (32°F to 104°F)
Storage Temp	-10°C to 50°C (10°F to 122°F)
Dimensions (L x H x W)	209 x 80 x 35 mm
Weight (exc test leads)	340 g inc batteries
Instrument accuracy is specified at:	Ambient Temp: 23°C ± 5°C Relative Humidity: <75%

# CONTENTS

<b>SAFETY INFORMATION</b> .....	<b>4</b>
Preliminary .....	4
During Use .....	4
Symbols .....	5
<b>DESCRIPTION</b> .....	<b>6</b>
Components of the Meter.....	6
<b>SWITCHES, PUSHBUTTONS AND INPUT JACKS</b> .....	<b>9</b>
Liquid Crystal Display (LCD) .....	9
<b>OPERATION INSTRUCTIONS</b> .....	<b>10</b>
Holding Readings .....	10
Switching Ranges .....	10
Switching Maximum Value .....	10
Switching Functions .....	11
Back Light and Clamp Light Bulbs .....	11
Low Battery Indicator .....	11
Auto Power-Off .....	11
Measuring AC Current .....	12
Measuring AC Voltage .....	13
Measuring DC Voltage .....	15
Measuring Resistance .....	17
Testing Diodes .....	19
Testing Continuity .....	20
<b>MAINTENANCE</b> .....	<b>22</b>
General Care .....	22
Replacing The Batteries .....	22
Replacing Test Leads .....	22
Calibration .....	22
<b>DECLARATION OF CONFORMITY</b> .....	<b>23</b>

## SAFETY INFORMATION



### **WARNING**

Take care when using this meter. Improper use can result in electric shock or damage to the meter. Take all normal safety precautions and follow the safeguards suggested in this manual.

### **PRELIMINARY**

1. When using the meter, the user must observe all normal safety rules concerning:
  - General protection against electric shock
  - Protection of the meter against misuse.
2. When the meter is delivered confirm it has not been damaged in transit.
3. The test leads must be kept in good condition. Before using, check that the insulation on the test leads has not been damaged or any wire exposed.
4. Use only the test leads supplied to ensure operational safety. If necessary, they must be replaced with test leads of the same model or class.

### **DURING USE**

1. Do not take measurements that exceed the maximum values for this meter.
2. Do not touch the metal probes of the test leads when the meter is connected to the circuit being measured.
3. Keep your fingers behind the probe barriers when taking measurements.
4. Do not take voltage measurements if you suspect the value exceeds 600V.
5. If the appropriate value range is unknown, select the highest range on the scale.
6. Disconnect the test leads from the circuit under test before turning the rotary function selector.
7. Do not measure the resistance, diode or continuity of live circuits.
8. Do not connect the meter to any voltage source while the rotary selector is in the Current, Resistance, Diode or Continuity range.

9. Do not use the meter near explosive gases or steam.
10. Stop using the meter if any abnormalities or faults are observed.
11. Do not use the meter unless its rear case and battery cover is correctly and securely fastened.
12. Do not store or use the meter in areas exposed to direct sunlight, at high temperature or with high relative humidity.
13. To avoid false readings, replace the batteries as soon as the Low Battery indicator appears.
14. Before use, verify the meter operation by measuring a known voltage.
15. Never touch exposed wiring, connections or any live circuit while taking any measurements.
16. Keep your body isolated from ground by using dry clothing, rubber shoes, rubber mats or any approved insulating material.

## SYMBOLS



Caution, risk of danger.



Beware electrical hazards.



Double insulation (Protection class II).



Conforms to the European Union Directive



Earth (ground) terminal

---

## DESCRIPTION

---

This meter is a portable, professional, measuring instrument with a Liquid Crystal Display (LCD) and back light for easily reading.

The meter can perform measurements of AC current, AC/DC voltage, resistance, as well as continuity and diode testing. Both Auto range and Manual ranges are available.

The meter is equipped with a reading hold function, a maximum value measuring function and the function of auto power off.

### COMPONENTS OF THE METER

1. Current Clamp
2. Clamp Lighting Bulb
3. Panel
4. Trigger
5. Back Light Button
6. Function Button (SEL)
7. MAX Button (MAX)
8. Liquid Crystal Display (LCD)
9. COM Jack
10. Input Jack
11. Range Button (RAN)
12. Display Hold Button (HOLD)
13. Rotary Selector
14. OFF - Power Switch
15. Rear Case
16. Fixing Screw (Battery Cover)
17. Battery Cover

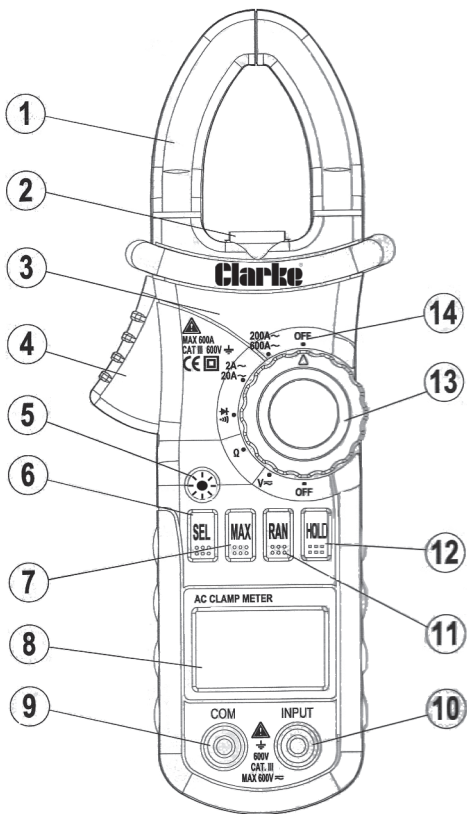

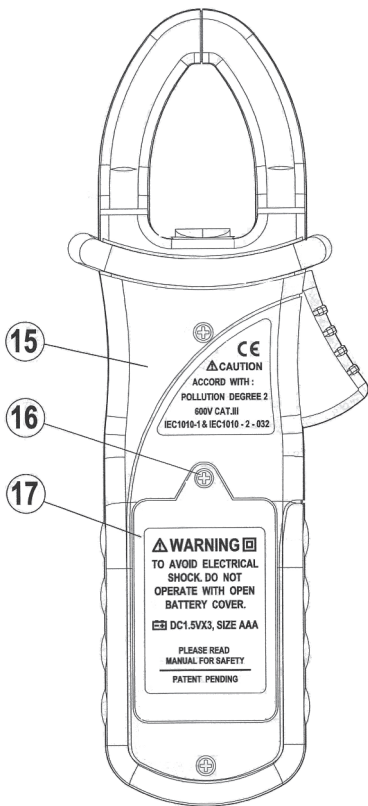







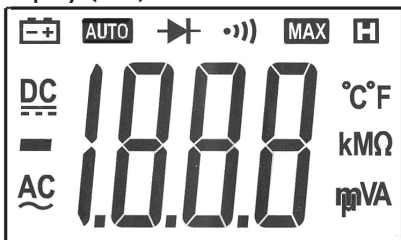

## SWITCHES, PUSHBUTTONS & INPUT JACKS

 Button	For controlling the backlight.
<b>SEL</b> Button	For switching between measuring functions.
<b>MAX</b> Button	For switching to maximum measurement value.
<b>RAN</b> Button	For switching between Auto and Manual ranges.
<b>HOLD</b> Button	For holding the reading (display hold).
<b>INPUT</b> Jack	For measuring voltage, resistance, diode and continuity.
<b>COM</b> Jack	Common input connection for current, voltage, resistance, diode and continuity measurement.
<b>OFF</b> Position	For turning off the power.
Rotary selector	For selecting functions and ranges.
Clamp	For measuring current.

## Liquid Crystal Display (LCD)



	Alternating current
	Direct current
	Diode test
	Continuity buzzer
<b>AUTO</b>	Auto range mode
<b>MAX</b>	The maximum value is being measure
	Battery low
<b>H</b>	This indicates that the display data is being held.
<b>mV, V</b>	Milli-volts, Volts (Voltage)
<b>A</b>	Amperes (Current)
<b>Ω, kΩ, MΩ</b>	Ohms, Kilo-ohms, Mega-ohms (Resistance)

---

## OPERATION INSTRUCTIONS

---

1. Switch on the power by turning the rotary selector. If the battery voltage is low, the  symbol will appear and the batteries should be replaced.
2. Turn the rotary selector to the required function to be measured. Choose the highest range when the value to be measured is unknown.
3. Connect the earth test lead before the positive test lead when making the connection. Remove the positive test lead first when disconnecting.

### SELECTING RANGES

When the meter is turned on, it will be in the Auto Range mode for measuring current, voltage, resistance and continuity.

1. Press the **RAN** button for Manual Range mode. The range will go up one level at each press and return to the lowest level when the highest level is reached.
2. Press the **RAN** button, for two or more seconds to return to the Auto Range.
3. Press the **RAN** button when measuring the maximum or minimum value, and the meter will return to the normal working condition.

### SELECTING FUNCTIONS

1. Press the **SEL** button to switch between AC and DC voltage measurement ranges.
2. Press the **SEL** button to switch between diode and continuity measuring ranges.

### HOLDING READINGS

1. Press the **HOLD** button to hold the readings while taking measurements.
  - The value on the display will be held.
2. Press the **HOLD** button again to release the function.

### SELECTING MAXIMUM VALUE

1. Press the **MAX** button to show the maximum value measured.
2. Press the **MAX** button again to return to standard mode.

## BACKLIGHT AND CLAMP LIGHTING BULB

1. Press the  button for two or more seconds to switch the backlight on and off.
  - When the back light is switched on at the current range, the clamp lighting lamp will illuminate.
  - The backlight will turn off automatically after 15 seconds.

### NOTE:

- Frequent use of the back light will shorten the life of the batteries and therefore it should not be used unnecessarily.

## LOW BATTERY INDICATOR

When the battery voltage is below 3.6V, the symbol,  (battery low) will appear on the LCD. The accuracy of measurement cannot be assured when the symbol appears.

### NOTE:

- When the back light is on, the Battery Low symbol may appear due to the current drawn causing the voltage to drop. In this case, there is no need to replace the batteries until the Low Battery symbol appears when the back light is not being used.

## AUTO POWER OFF

1. If the meter is not used within fifteen minutes of being switched on, the meter will 'Auto Power-Off'.
2. Turn the rotary selector or press any button to resume operation of the meter in the 'Auto Power-Off' mode.
3. When powering up, if the **HOLD** button is pressed, the 'Auto Power-Off' function is disabled.

## MEASURING AC CURRENT

Ensure the test leads are disconnected from the meter before making current clamp measurements.

1. Turn the rotary selector to the **A** range position.
2. Press the **RAN** button if required, to choose the Manual Range mode.
3. Squeeze the trigger to open the jaw and fully enclose only one conductor.
4. Take the reading showing on the LCD.

### NOTE:

- For accurate results, do not enclose more than one conductor in the jaws.

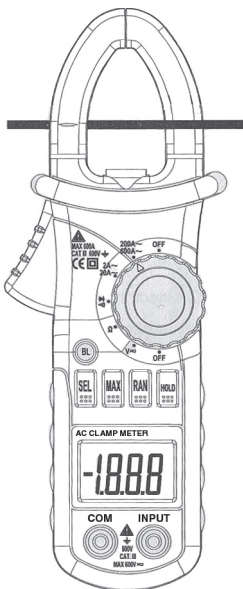

**Correct**

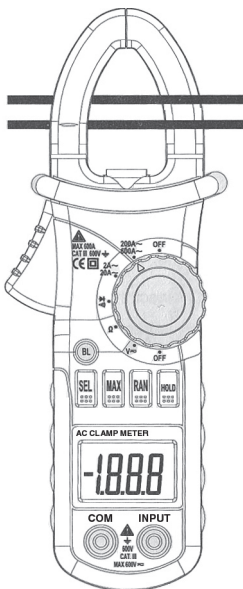

**Incorrect**

- For optimum results, centre the conductor in the jaws.
- If **OL** is displayed when in manual mode, the measurement has exceeded the selected range and a higher one should be selected.
- Select the highest available range in the Manual Range mode, when the scale of the value to be measured is not known.
- The maximum permitted input current for the meter is 600A rms AC.

Range	Resolution	Accuracy
2A	0.001A	$\pm (3.5\% \text{ of rdg} + 20 \text{ digits}) < 0.5A$
		$\pm 3.0\% \text{ of rdg} + 10 \text{ digits}$
20A	0.01A	$\pm 3.0\% \text{ of rdg} + 10 \text{ digits}$
200A	0.1A	$\pm 2.5\% \text{ of rdg} + 10 \text{ digits}$
600A	1A	$\pm 1.5\% \text{ of rdg} + 5 \text{ digits}$

- Max input current:- 600A.
- Frequency range:- 50 to 60Hz.
- Response average:- calibrated in rms of sine wave.

## MEASURING AC VOLTAGE

**Pay special attention to avoid electric shock when measuring high voltages.**

**Do not connect to a voltage greater than 600V rms AC.**

1. Plug the black test lead into the **COM** jack and the red test lead into the **INPUT** jack.
2. Turn the rotary selector to the V~ position, setting the meter to the AC V measurement mode.
3. Press the **RAN** button if required, to choose the Manual Range mode.
4. Connect the test leads to the voltage source for measurement.
5. Note the reading on the LCD.

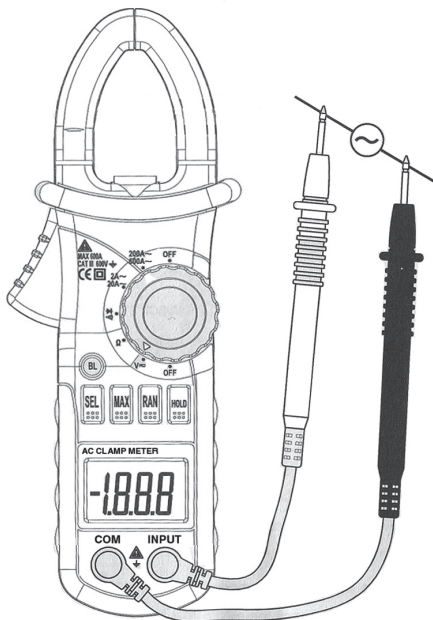

**NOTE:**

- At a low voltage range, unsteady readings may appear before the test leads touch the circuit. This is normal because the meter is highly sensitive. When the test leads contact the circuit, the true reading will be shown.
- If **OL** is displayed when in manual mode, the measurement has exceeded the selected range and a higher one should be selected.
- In the Manual Range mode, when the value to be measured is not known, select the highest range first and lower the range gradually.
- The maximum permitted input voltage for the meter is 600V rms AC.

Range	Resolution	Accuracy
200mV	0.001V	± 3.5% of rdg +20 digits
2V	0.001V	± 3.0% of rdg +10 digits
20V	0.01V	± 3.0% of rdg +10 digits
200V	0.1V	± 2.5% of rdg +10 digits
600V	1V	± 1.5% of rdg +5 digits

- Input impedance 10M $\Omega$ .
- Overload protection: 200mV range: 25V DC or rms AC, 2V-600V ranges: 600V DC or rms AC.
- Max. input voltages 600V rms AC.
- Frequency range: -40 to 200Hz.
- Response average, calibrated in rms of sine wave.

## MEASURING DC VOLTAGE

**Pay special attention to avoid electric shock when measuring high voltage.**

**Do not connect to a voltage greater than 600V DC.**

1. Plug the black test lead into the **COM** jack & the red lead into the **INPUT** jack.
2. Turn the rotary selector to the **V**  position.
3. Press the **SEL** to switch to DC V measurement. If required, press the **RAN** button to choose the Manual Range mode.
4. Connect the leads to the voltage source or load terminals for measurement.
5. Take the reading on the LCD. The polarity symbol - indicates the polarity of the DC voltage source. It may also indicate an inadvertently reversed probe connection.

### NOTE:

- At the lower voltage range, unsteady readings will appear before the test leads touch the circuit. This is normal because the meter is highly sensitive. When the test leads touch the circuit, the true reading will be shown.





Range	Resolution	Accuracy
200mV	0.1mV	± 0.8% of rdg + 2 digits
2V	0.001V	
20V	0.01V	
200V	0.1V	
600V	1V	± 1.0% of rdg + 2 digits

## MEASURING RESISTANCE

When measuring in-circuit resistance, ensure the circuit under test has been turned off and that all capacitors have been fully discharged.

1. Plug the black test lead into the **COM** jack & the red lead into the **INPUT** jack.
2. Turn the rotary selector to the  $\Omega$  position.
3. Press the **RAN** button to choose the Manual Range mode if required.
4. Connect the test leads to the ends of the resistor or circuit for measurement.
5. Note the reading on the LCD.

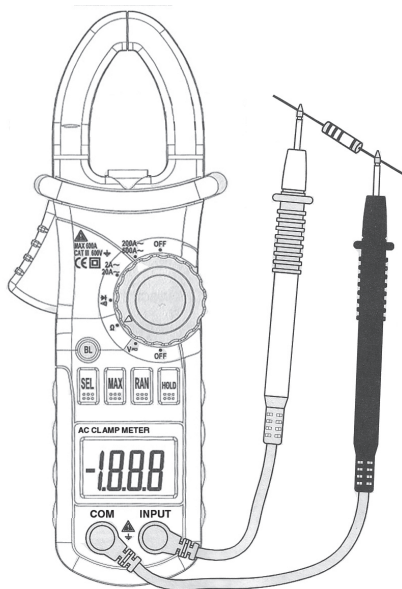

Range	Resolution	Accuracy
200 ohm	0.1 ohm	± 1.2% of rdg + 2 digits
2k ohm	0.001k ohm	
20k ohm	0.01k ohm	
200k ohm	0.1k ohm	
2M ohm	0.001M ohm	
20M ohm	0.01M ohm	± 2.0% of rdg + 5 digits

- Open circuit voltage: 0.25V
- Overload protection: 250V DC or rms AC

**NOTE:**

- If only **OL** is shown on the LCD while in Manual mode, it means the measurement has exceeded the range and a higher range must be selected. It may also mean the circuit is not connected.
- When the input is open, **OL** will appear on the LCD to indicate that the range has been exceeded.
- For measuring resistance above 1 M $\Omega$ , it may take a few seconds to get a steady reading. This is normal for a high resistance reading.

**TESTING DIODES**

1. Plug the black test lead into the **COM** jack & the red lead into the **INPUT** jack.

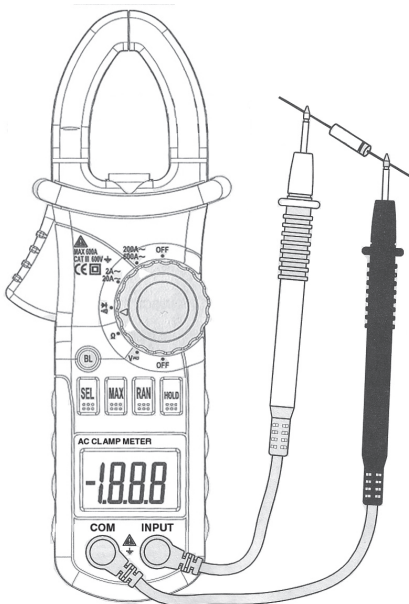



2. Turn the rotary selector to the  position.
3. Connect the red test lead to the anode and the black test lead to the cathode (black striped end) of the diode for testing.
4. Take the reading on the LCD.

**NOTE:**

- The meter will show the approximate forward voltage drop of the diode.
- When the test leads have been reversed or open, **OL** will appear on the LCD.
- Forward DC current :- 1mA
- Reversed DC voltage: - 1.5V
- Overload protection: 250V DC or rms AC

## TESTING CONTINUITY

**Make sure that the circuit has been turned off and the capacitors have been fully discharged before testing the continuity of a circuit.**

1. Plug the black test lead into the **COM** jack & the red lead into the **INPUT** jack.
2. Set the rotary selector to the  position.
3. Press the **SEL** button to switch to  continuity test.
4. Connect the test leads to the two ends of the circuit for measurement.
5. If there is continuity in the circuit being tested, the buzzer will sound.
6. If the test leads are open, OL will be displayed on the LCD.

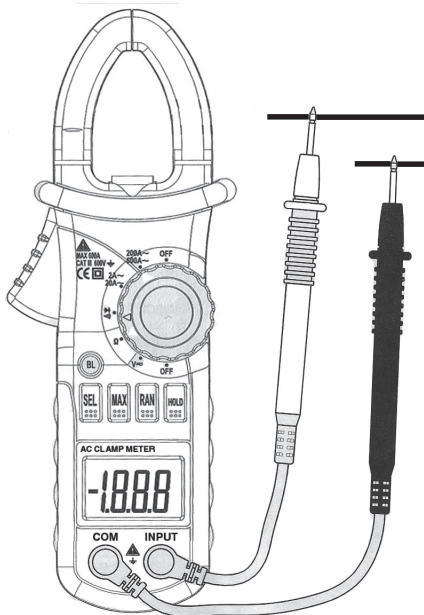

- Open circuit voltage: -0.45V
- Overload protection: 250V DC or rms AC

---

## **MAINTENANCE**

---

### **GENERAL CARE**

1. Turn the rotary selector to OFF position to switch off the power when the meter is not in use.
2. Remove the batteries to avoid damage to the meter if it will remain unused for a long time.
3. Do not attempt to remove the rear case to adjust or repair the meter. Repairs should only be performed by a qualified technician.
4. Use a damp cloth and mild detergent to clean the meter. Do not use abrasives or solvents.

### **BATTERY REPLACEMENT**

The batteries required are 3 x 1.5V AAA.

1. Disconnect the test leads from sources of electric current before opening battery cover. Loosen the fixing screw on the battery cover and remove it.
2. Replace the exhausted batteries with new ones. Take care that the polarity of the batteries are correct, as marked on the inside of the housing.
3. Put the battery cover back and secure with the fixing screw.
4. Dispose of your old batteries in accordance with local regulations.

### **REPLACING THE TEST LEADS**

The replacement leads must be in good condition with the same rating as the originals i.e. 1000V, 10 A.

A test lead must be replaced if the insulation layer has been damaged.

### **CALIBRATION**

Calibration should be carried out once a year at a temperature between 18°C and 28°C (64°F to 82°F) and relative humidity below 75%.

# DECLARATION OF CONFORMITY



**Clarke**<sup>®</sup>  
**INTERNATIONAL**

Hemnall Street, Epping, Essex CM16 4LG

## DECLARATION OF CONFORMITY

**This is an important document and should be retained.**

**We hereby declare that this product(s) complies with the following directive(s):**

2014/30/EU      *Electromagnetic Compatibility Directive.*  
2014/35/EU      *Low Voltage Equipment Directive.*  
2011/65/EU      *Restriction of Hazardous substances (Amended by (EU) 2015/863).*

**The following standards have been applied to the product(s):**

*EN 61010-2-032:2012, EN 61010-1:2010, EN 61010-2-033:2012,  
EN 61326-2-2:2013, EN 61326-1:2013.*

The technical documentation required to demonstrate that the product(s) meet(s) the requirement(s) of the aforementioned directive(s) has been compiled and is available for inspection by the relevant enforcement authorities.

The CE mark was first applied in: 2007

**Product Description:**            Digital Clamp Multimeter  
**Model number(s):**            CDM95  
**Serial / batch Number:**        N/A  
**Date of Issue:**                02/06/2020

**Signed:**

**J.A. Clarke**  
**Director**

# A SELECTION FROM THE VAST RANGE OF

# Clarke®

## QUALITY PRODUCTS

### AIR COMPRESSORS

From DIY to industrial, Plus air tools, spray guns and accessories.

### GENERATORS

Prime duty or emergency standby for business, home and leisure.

### POWER WASHERS

Hot and cold, electric and engine driven - we have what you need

### WELDERS

Mig, Arc, Tig and Spot. From DIY to auto/industrial.

### METALWORKING

Drills, grinders and saws for DIY and professional use.

### WOODWORKING

Saws, sanders, lathes, mortisers and dust extraction.

### HYDRAULICS

Cranes, body repair kits, transmission jacks for all types of workshop use.

### WATER PUMPS

Submersible, electric and engine driven for DIY, agriculture and industry.

### POWER TOOLS

Angle grinders, cordless drill sets, saws and sanders.

### STARTERS/CHARGERS

All sizes for car and commercial use.

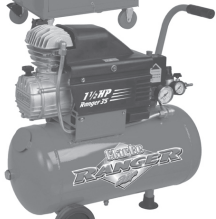

**PARTS & SERVICE: 0208 988 7400**

**E-mail: [Parts@clarkeinternational.com](mailto:Parts@clarkeinternational.com) or [Service@clarkeinternational.com](mailto:Service@clarkeinternational.com)**

**SALES: UK 01992 565333 or Export 00 44 (0)1992 565335**

**Clarke** INTERNATIONAL Hemnall Street, Epping, Essex CM16 4LG  
[www.clarkeinternational.com](http://www.clarkeinternational.com)